

# REDLAND DRY VALLEY

Installation Instructions for Redland Dry Valley



Version: 6

Date: May 2013

Author: Redland Technical Solutions

Department: Redland Technical Solutions

# 1 Introduction

## 1.1 TECHNICAL DATA

Dimensions: 3 m long x 360 mm wide

Material: Glass-fibre/polyester composite manufactured with the base in a flat plane, the flexibility of the profile allowing internal angles of 12.5° to 60° to be achieved.

Pitch Range: 17.5°-60° with a maximum difference between the two adjacent roof pitches of 20°.

Roof Area on Plan draining into valley: Maximum 100 m<sup>2</sup>.

Maximum Rafter Length: 10 m (on plan) (or Maximum Valley Length 14 m (on plan)). For longer rafter lengths contact Redland Technical Solutions to check suitability (Tel. 08708 702595).

Plan Angle of Valley: For rafter pitches 17.5°-60° there are no restrictions on Plan Angle of Valley.

No sealing or jointing material is required if the following overlaps are used for adjoining Redland Dry Valley sections :

Rafter Pitch	Below 22.5°	22.5-29°	30-39°	Over 39°
<b>Overlap</b>	350 mm	300 mm	200 mm	150 mm

## 1.2 DESCRIPTION

Redland Dry Valley is a valley product designed for tiled pitched roofs and is manufactured from glass-fibre/polyester laminates in a continuous process to two profiles:

Dry Valley for Low Profile Tiles (9575) – with central upstand 80 mm, available in standard lead grey colour in 3 m lengths.

Compatible with double lapped natural slates and fibre-cement slates, flat interlocking tiles including all Redland Slate Range tiles (Cambrian Slate, Landmark Slate 10, Richmond 10, Saxon 10, Mockbond Richmond 10, Mini Stonewold, Mockbond Mini Stonewold, Stonewold II) and Redland DuoPlain.

Dry Valley for High Profile Tiles (9574) – with central upstand 105 mm, available in standard lead grey colour in 3 m lengths.

Compatible with double lapped plain tiles including Redland Plain Tile, Heathland, Rosemary Clay, profiled interlocking tiles including all Redland Profile Range tiles (Cathedral Clay Pantile, Old Hollow Clay Pantile, Landmark Double Pantile, Landmark Double Roman, Grovebury, 50 Double Roman, Regent, Renown, Norfolk Pantile, 49 Tile), and metal profiled sheet.

For other roof coverings please contact Redland Technical Solutions (Tel. 08708 702595) to check suitability.

The Dry Valleys are designed to fit directly onto either existing or new valley support boards.

## 1.3 STORAGE

The Dry Valleys can be stored outside above the ground on a flat, clean and level surface. The profiles should be stacked such that crushing and distortion is avoided and for long or indeterminate periods of storage outside the Dry Valleys should be protected with an opaque weatherproof covering.

## 2 Installation

### 2.1 GUIDANCE NOTES

Redland Dry Valleys are fitted in all circumstances to a supporting valley board or sarking board. The valley board can be of the inset type between and flush with the top of the rafters, or overlaid on top of the rafters (for close-boarded roofs or roofs to be counter-battened). The inset boards should be a minimum of 12 mm thick plywood and overlaid boards a minimum of 6 mm thick plywood.

Roofs intersecting at 90° are regarded as a standard intersection, for roofs of a non-standard intersection please contact Redland Technical Solutions on Tel. 08708 702595.

Dormer details occurring mid roof slope will require the foot of the Dry Valley to be flashed out on to the main roof slope in Rapid Flashing or lead; the intersecting head of the valleys should also have a Rapid Flashing or lead saddle fitted over.

Redland Dry Valleys are suitable for both traditional cold roof and warm roof construction. In the latter case, where the insulation follows the rafter line, there are many different ways of constructing the roof. Many of these warm constructions include a requirement for counterbattens below the slating or tiling battens. It is therefore recommended, whether using a traditional or vapour permeable underlay, that provision for roofspace ventilation is made to suit the application in accordance with the requirements of BS 5250:2011.

### 2.2 VALLEY BOARD CONSTRUCTION AND FIXING DRY VALLEY

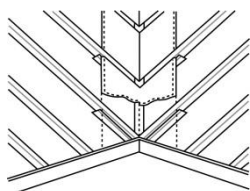

#### Valley Board Construction

In all cases valley boards should be fitted. Valley boards may be inset or continuous over the rafters. Where they are inset, they should be a minimum of 12mm thick and supported on bearers of 50 x 25mm or similar and set at a depth to suit the thickness of the Valley Board.

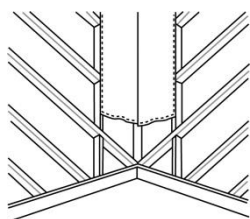

Continuous overlaid boards should be minimum of 6mm thick plywood and butt jointed only over a supporting rafter.

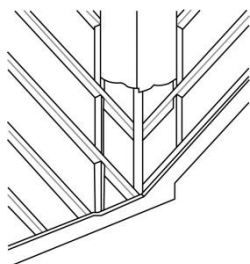

The width of the valley boards should extend by a minimum of 50mm beyond the edge of the Dry Valley. For overlaid boards on rafter spacings above 450mm, it is recommended that support noggins of 75 x 50mm are fixed under the outer edge of the valley board between the rafters.

The fascia or barge board may be trimmed to allow the Dry Valley to pass through without flattening the profile, or alternatively a lead or Rapid Flashing saddle may be used if required.

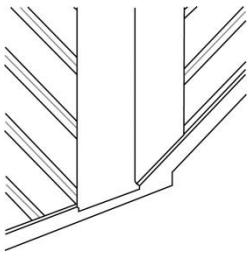

### Lining the Valley

A single strip of roofing underlay, at least the full width of the valley boards, should be laid up the centre and directly on top of the boards allowing for an overlap beyond the fascia line where appropriate and which may be trimmed later.

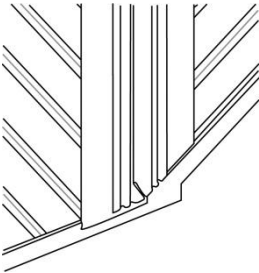

**Fixing the Dry Valley** When fixing the Dry Valley, the raised centre section should be pinched together at the base and the trough pushed down firmly, locating it centrally onto the valley boards. Prior to doing this the cavity under the raised central upstand section at the bottom of the Dry Valley is closed using Redland Kompriband expandable foam (946700). See Section 2.5 for how the Dry Valley should be finished at eaves.

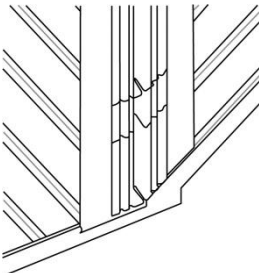

The foot of the Dry Valley, when discharging into the eaves gutter should be trimmed either prior to fixing or in-situ to provide a 50mm overhang into the guttering.

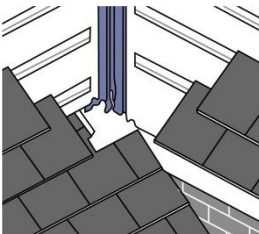

Where a lead or Rapid Flashing saddle is to be used at the foot of the valley, i.e. where the Dry Valley terminates above eaves level or where an eaves intersects with a verge or it is not appropriate to notch the fascia boards, the saddle should be welted at the edge and supported with suitable timber work. The Dry Valley should be trimmed to suit before fixing if necessary.

### Joining Valley Sections

Additional lengths can be joined by overlapping. No sealant or jointing materials is required if the following overlap lengths are used:

Roof Pitch	Over 39°	30°- 39°	22.5°- 29°	Below 22.5°
Overlap	150mm	200mm	300mm	350mm

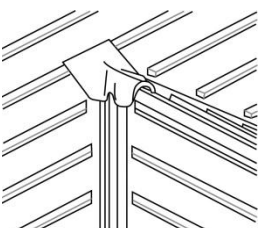

### Valley Intersections

Where a section of Dry Valley intersects with another section of Dry Valley e.g. at the ridge of a dormer roof or where one or more sections intersect with the ridge of a roof, it is necessary to mark the angle of intersection and cut the Dry Valley to a mitre prior to fixing.

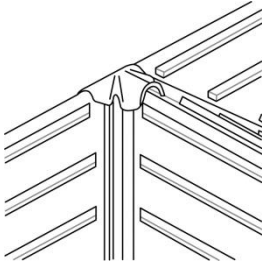

A minimum Code 4-lead saddle or Redland Rapid Flashing saddle should then be dressed over the mitred sections of the Dry Valley(s) and ridge if necessary. The length of the overlap of a lead saddle onto the Dry Valley should be in accordance with the overlap lengths above. Alternatively, when using Rapid Flashing the overlap over the Dry Valley must be a minimum 50mm including the butyl sealing strip. See Section 2.5 for how the saddle can be formed using Rapid Flashing. A lead or Rapid Flashing saddle may also be dressed over the slates or tiles if desired.

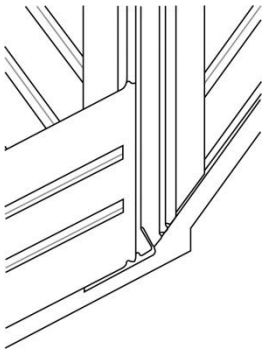

### **Installation of Underlays and Battens**

The underlay can now be installed in the recommended manner and overlapped onto the Dry Valley before trimming between the two outer water bars either side of the central upstand.

The battens should be mitre cut to the angle of the valley, located on to the flat outer flanges of the Dry Valley and nailed to the supporting timber work outside the line of the Dry Valley.

## 2.3 INTERLOCKING ROOF TILES

Tile the roof to within one full tile width of the central upstand the full length of the valley. Measure the cover width (CW) of the tile being used, double this measurement and transfer it from the side of the central upstand closest to the tiles to be cut and in line with the coursing of the tiles. Mark the bottom edge of the first tile at the base of the valley and the last tile at the top of the valley. It is important for the tape measure to be on top of the tile when transferring this measurement.

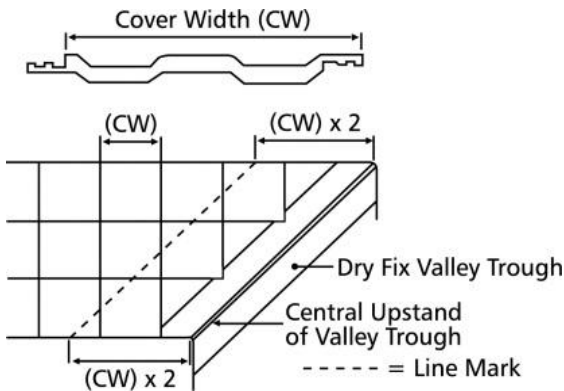

Using a chalk line (or straight edge) between the two marked points, snap a line to establish the position of the cuts to be made. When using a chalk line to mark the cut in profiled tiles, it may be necessary to mark the tiles further using a straight edge. The tiles may be numbered or marked prior to removal from the roof to establish the correct repositioning after cutting.

Replace each removed tile with a full tile. The cut tiles can then be fitted back into the appropriate course, taking care not to force the tiles too heavily against the central upstand to avoid distortion and maintain the straight line appearance of the valley.

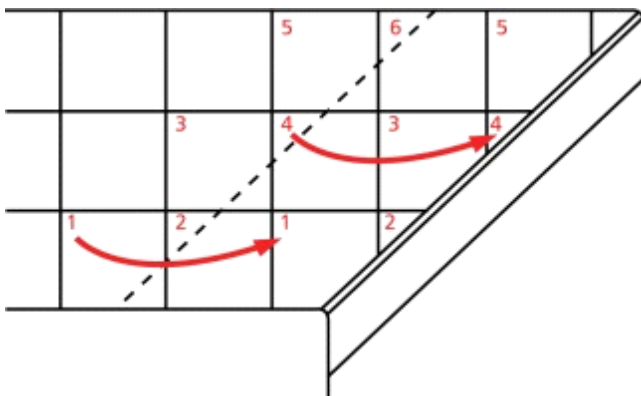

Where small cuts of tiles occur, and there is sufficient support from adjacent tiles to the side of the valley, it becomes necessary to use the Redland C-clip (9518) to hold the interlock together, and the Redland Kro-clip (9142) which is secured at one end to the cut tile and at the other end via a wire to the tiling batten. The recommended fixing specification is 1 x Kro-clip on the cut edge of the tile and 2 x C-clips, one at the head and one at the tail of the coverlock/interlock junction with the adjacent tile. For Cambrian Slate, Double slates are required on all courses on both sides of Dry Valley below 25 degrees rafter pitch. At pitches of 25 degrees and above, Slate-and-a-halves can be used. In either case follow the fixing instructions in Section 2.3.2 for fixing of the cut Cambrian Slates into the valley.

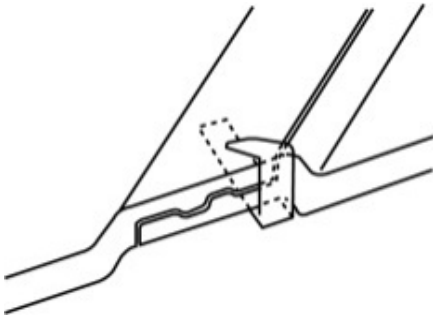

Redland C-clip (9518)

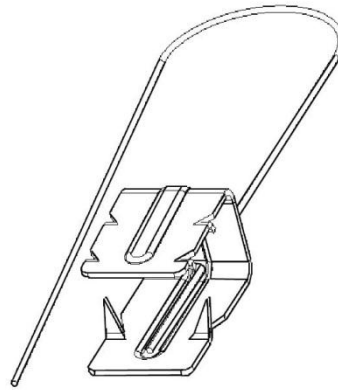

Redland Kro-clip (9142)

### 2.3.1 INSTALLATION OF DRY VALLEY WITH FLAT INTERLOCKING ROOF TILES



The use of valley boards is essential to support the Dry Valley. Line the valley with a single length of underlay to at least the full width of the valley boards. Press the upstand of the Dry Valley together and position it centrally in the valley – pushing down firmly to ensure full contact with valley boards. When joining lengths of valley trough use the recommended minimum overlaps in Section 1.1. Nail through the outer flange of the Dry Valley into the valley boards at maximum 500 mm centres. Mark out the tiles to establish the position of the tile cuts to be made. A line is drawn 2 x Cover Width of Tile away from central upstand of Dry Valley using a straight edge or chalk line.



The fascia board can be cut to allow the Dry Valley to pass through without flattening the profile, or alternatively, a Rapid Flashing saddle may be used if required.

Once the tiles are marked the tiles should be cut following HSE Guidelines.



Lay the cut tiles close up to the central upstand of the Dry Valley and complete the tile coursing as normal. Repeat the process above for both sides of the valley.



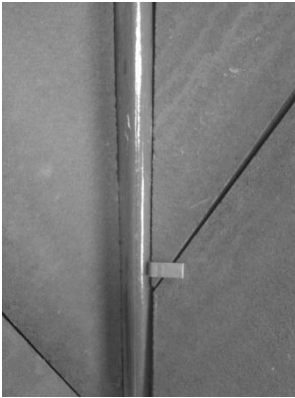

Ensure small tile cuts that cannot be mechanically fixed in the normal way at the head of the tile are secured using Redland C-clips (9518) (shown adjacent), and Redland Kro-clips (9142). It is recommended 2 x C-clips are used both at the head and tail of the coverlock/interlock junction with the adjacent tile, and 1 x Kro-clip is used at the free cut edge of the tile.

Fit a Rapid Flashing saddle at the head of the valley.

### 2.3.2 INSTALLATION OF DRY VALLEY WITH CAMBRIAN SLATES



When installing a Dry Valley with Cambrian Slates additional valley battens must be fixed up entire length of valley on both sides of the Dry Valley as shown to provide fixing points for Cambrian Slate Verge Clips (9193). The position of the verge clip may need to be adjusted slightly during setting out to avoid coinciding with the raised nail boss area of the cut Cambrian Slate. The Verge Clip should be screwed into the valley batten using a 25 mm long stainless steel screw. Aluminium alloy felt tacks should be used either side of the clip as shown to stop possible rotation of the clip during service.



Double slates are required on all courses on both sides of Dry Valley below 25 degrees rafter pitch. At pitches of 25 degrees and above, Slate-and-a-half can be used.

The cut eaves course Cambrian Slate-and-a half or Double slate must be twice screw-fixed at the head of the slate through the remaining nail-holes using 30 x 3.5 mm countersunk posi-drive stainless steel screws (9356).



The remaining cut Cambrian Slate-and-a-half or Double Slates must be twice nailed using 30 x 2.65 mm stainless steel annular ring-shanked nails and tail clipped using verge clips (9193) as shown.



### 2.3.3 INSTALLATION OF DRY VALLEY WITH PROFILED INTERLOCKING ROOF TILES



The use of valley boards is essential to support the Dry Valley. Line the valley with a single length of underlay to at least the full width of the valley boards. Press the upstand of the Dry Valley together and position it centrally in the valley – pushing down firmly to ensure full contact with valley boards. When joining lengths of valley trough use the recommended minimum overlaps in Section 1.1. Nail through the outer flange of the Dry Valley into the valley boards at maximum 500 mm centres. Mark out the tiles to establish the position of the tile cuts to be made. A line is drawn 2 x Cover Width of Tile away from central upstand of Dry Valley using a straight edge or chalk line. Cut the tiles as required following HSE Guidelines.



The fascia board can be cut to allow the Dry Valley to pass through without flattening the profile, or alternatively, a Rapid Flashing saddle may be used if required.

Lay the cut tiles close up to the central upstand of the Dry Valley and complete the tile coursing as normal.

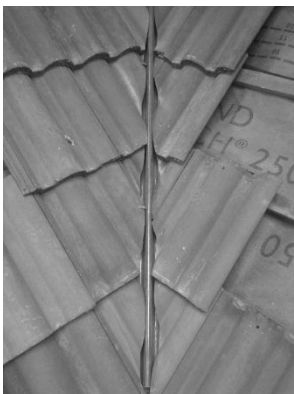

Repeat the process above for both sides of the valley.



Ensure small tile cuts that cannot be mechanically fixed in the normal way at the head of the tile are secured using Redland C-clips (9518) (shown adjacent), and Redland Kro-clips (9142). It is recommended 2 x C-clips are used both at the head and tail of the coverlock/interlock junction with the adjacent tile, and 1 x Kro-clip is used at the free cut edge of the tile.

Fit a Rapid Flashing saddle at the head of the valley.

## 2.4 INSTALLATION OF DRY VALLEY WITH PLAIN ROOF TILES (INCL. ROSEMARY CLAY PLAIN TILES) OR NATURAL SLATES

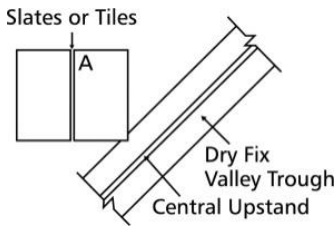

Commencing with the eaves courses and each subsequent course thereafter, the positioning, marking and cutting for both sides of the valley should be carried out in accordance with the following sequence:

Slate or tile the roof into the valley up to the last full slate or tile **A** that will fit.

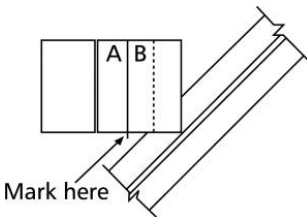

Place slate or tile **B** over **A** ensuring that the bottom edges are in line and the corner of **B** is lightly touching the central upstand of the Dry Valley. Mark the bottom edge of **A** where **B** overlaps.

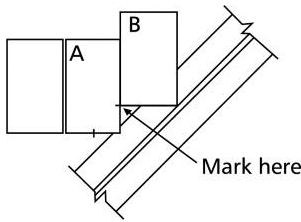

Repositioning slate or tile **B** alongside **A** with the bottom corner of **B** still in contact with the central upstand. Mark the side of **A** with the bottom edge of **B**.

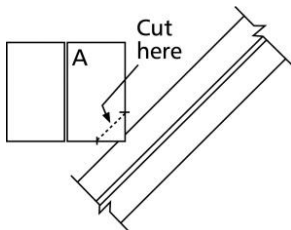

Remove slate or tile **A** and cut to the established marks.

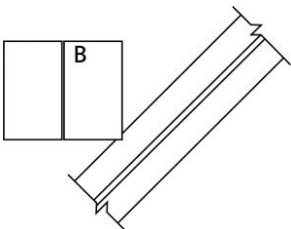

Position and fix full slate or tile **B** in position previously occupied by **A**.

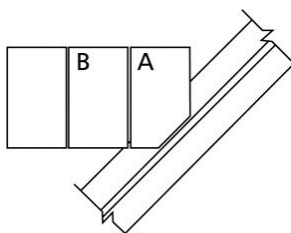

Fit slate or tile **A** against central upstand taking care not to nail through the valley or force the slate or tile against the central upstand to avoid distortion and maintain the straight-line appearance of the Dry Valley.

Note: to avoid small cuts of slate or tile occurring that are difficult to fix, it is recommended that a tile and a half or wider slate is used. If small cuts cannot be

avoided with plain tiles use the Redland Kro-clip (9142) to provide the mechanical fixing for the perimeter tile.

With the Dry Valley in position, it is nailed through the outer flange into the supporting timbers at 500mm centres maximum. The small exposed void in the upstand at the end of the Dry Valley at the eaves can be filled using a suitable mastic or foam.

See step-by-step photo instructions below for further guidance:

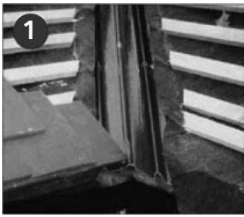

The first course is shown abutting the Dry Valley upstand - in this case there is no need to cut an angle as the next course will cover the gap on the eaves tile. Both under eaves and first course of tiles have nailing capability.



Tiles being cut to the correct angle to suit the Dry Valley upstand.

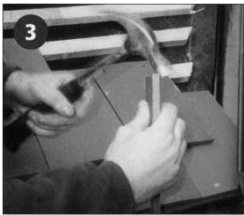

Removing the tile nib will prevent 'kicking up' on the Dry Valley water bar still allowing a nail hole for fixing.



Positioning the cut tile up the Dry Valley upstand.



The cut tile is then positioned and nailed, avoiding penetration of the Dry Valley.



Subsequent tile coursing in place.



The Dry Valley mitred at the ridge and awaiting the final tile course.



Small cut tiles should be avoided where possible. Tile and a halves may be used to avoid small cuts of tile. Where small cuts are unavoidable then Redland Kro-clips (9142) can be used to secure the cut tiles.



Here the lead saddle (alternatively Redland Rapid Flashing saddle) is dressed over the intersecting valleys and welted under the ridge tile for a dry ridge application.

## 2.5 FINISHING OF DRY VALLEY AT TOP AND BOTTOM

### 2.5.1. AT EAVES



To prevent birds, insects and rodents from entering it is important to close the cavity at the bottom of the Dry Valley. It is recommended that Redland Kompriband expandable foam (9467) is used to close off the cavity as shown in the photo adjacent. Peel off the backing off the sticky side and adhere the Kompriband to the inside bottom of the Dry Valley.

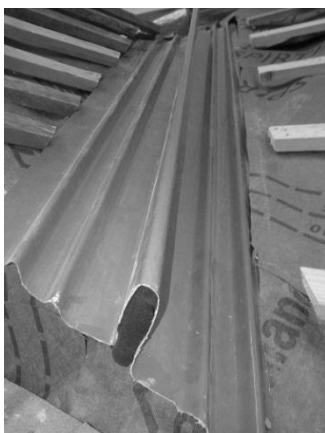

The Kompriband foam expands to fill the available space closing the cavity at the bottom of the Dry Valley at the eaves.

### 2.5.2. AT TOP OF TWO VALLEYS



Where two Dry Valleys meet at the top of two valleys first cut the Dry Valleys to meet at a mitred joint. The junction is then weather-proofed using 370 mm wide Rapid Flashing roll (9957) cut into four pieces and dressed as illustrated in this section.

The first Rapid Flashing piece to be cut should be rectangular on plan and long enough such that when dressed using a roller it overlaps the Dry Valley at the bottom and upstand on adjacent Dry Valley by a minimum 50 mm.

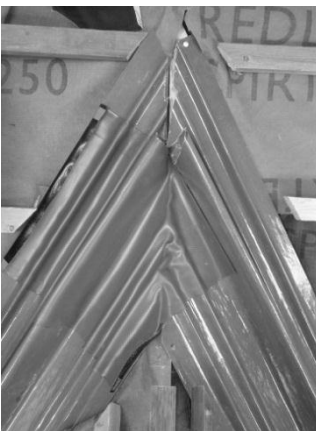

The Rapid Flashing piece should be fully dressed down and adhered to the Dry Valley with welts formed at the sides as shown.

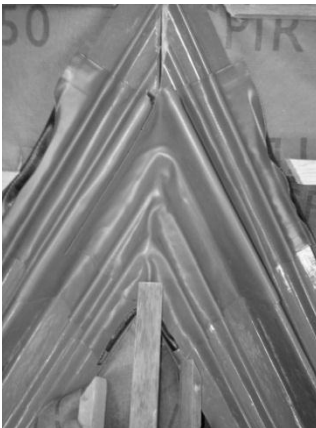

An identical second piece is cut, adhered to and dressed down over the Dry Valley on the other side of the mitred junction as shown.

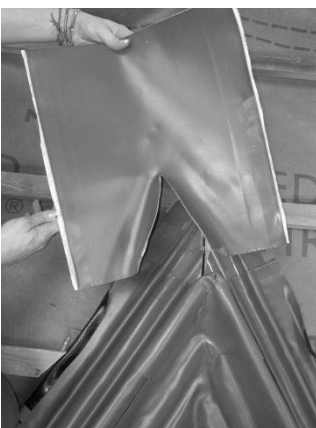

A third Rapid Flashing piece is cut as shown with a slit cut at one end and the flashing folded up to form a chevron.





This third piece is offered up to the back of the mitred junction and trimmed around the sides of the central upstands to a neat finish as shown. The third piece is adhered to the existing flashing pieces and dressed down using a roller as with the previous pieces.



A final shorter rectangular piece is then cut and stretched in middle as shown to form a rounded curved piece.



This final piece is adhered to the back of the mitred junction sealing over both central upstands and the third back piece. A roller should be used to dress the flashing down firmly and neatly.



With all pieces securely in place welts are formed around all edges of the Rapid Flashing, including the back edge, as shown.

The top of the two valleys is then ready to be tiled in as rest of tile fixing instructions.